

ProLight PG1N-1LXS
1W Power LED
Technical Datasheet
Version: 1.0

Features

- High Flux per LED
- Very long operating life(up to 100k hours)
- Available in White, Warm White, Green, Blue, Amber, Red-Orange and Red
- Lambertian or Collimated Radiation Pattern
- More Energy Efficient than Incandescent and most Halogen lamps
- Low Voltage DC operated
- Cool beam, safe to the touch
- Instant light (less than 100ns)
- No UV
- Superior ESD protection
- Soldering methods: IR reflow soldering and Hand soldering

Typical Applications

- Reading lights (car, bus, aircraft)
- Portable (flashlight, bicycle)
- Decorative
- Appliance
- Sign and Channel Letter
- Architectural Detail
- Cove Lighting
- Automotive Exterior (Stop-Tail-Turn, CHMSL, Mirror Side Repeat)
- LCD backlight

Mechanical Dimensions

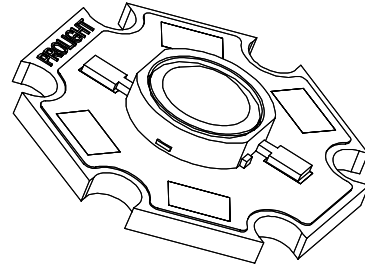
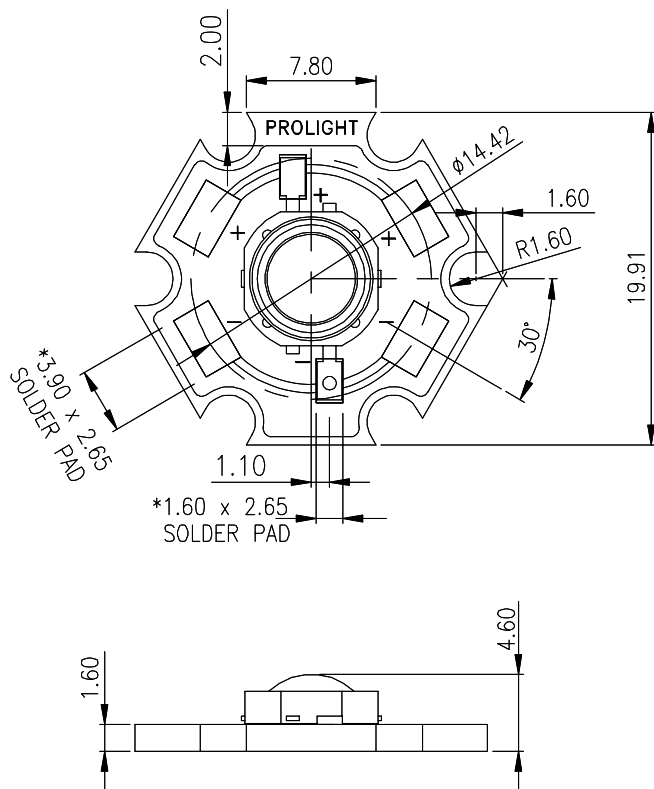

Notes:

1. Slots in aluminum-core PCB for M3 or #4 mounting screw.
2. Electrical interconnection pads labeled on the aluminum-core PCB with "+" and "-" to denote positive and negative, respectively. All positive pads are interconnected, as are all negative pads, allowing for flexibility in array interconnection.
3. Drawing not to scale.
4. All dimensions are in millimeters.

Part Number Matrix

Color	Emitter	STAR	Beam Pattern
White	PG1N-1LWE	PG1N-1LWS	
Warm White	PG1N-1LVE	PG1N-1LVS	
Green	PG1N-1LGE	PG1N-1LGS	
Blue	PG1N-1LBE	PG1N-1LBS	Lambertian
Amber	PG1N-1LAE	PG1N-1LAS	
Red-Orange	PG1N-1LHE	PG1N-1LHS	
Red	PG1N-1LRE	PG1N-1LRS	

Flux Characteristics at 350mA, Junction Temperature, T_j=25°C

Color	Minimum Luminous Flux (lm)	Typical Luminous Flux (lm)	Beam Pattern
White	30.6	40	
Warm White	23.5	36	
Green	23.5	35	
Blue	4.9	10	Lambertian
Amber	23.5	36	
Red-Orange	30.6	40	
Red	23.5	32	

Optical Characteristics at 350mA, Junction Temperature, T_j=25°C

Color	Dominant Wavelength λ_D			Spectral Half-width (nm) $\Delta\lambda_{1/2}$	Temperature Coefficient or Dominant Wavelength $\Delta\lambda_D/\Delta T_j$ (nm/°C)
	Peak Wavelength λ_p	Color Temperature(CCT)			
	Min.	Typ.	Max.		
White	4500K	5500K	10000K	-	-
Warm White	2850K	3300K	3800K	-	-
Green	520nm	530nm	550nm	35	0.04
Blue	460nm	470nm	490nm	25	0.04
Amber	584.5nm	590nm	597nm	20	0.05
Red-Orange	610nm	617nm	620.5nm	20	0.05
Red	620.5nm	625nm	645nm	20	0.05

**Optical Characteristics at 350mA, Junction Temperature, T_j=25°C
(Continued)**

Color	Beam Pattern	Total Included Angle θ0.9v (degree)	Viewing Angle 2θ1/2 (degree)	Typical Candela on Axis (cd)
White		160	140	
Warm White		160	140	
Green		160	140	
Blue	Lambertian	160	140	
Amber		160	140	
Red-Orange		160	140	
Red		160	140	

Electrical Characteristics at 350mA, Junction Temperature, T_j=25°C

Color	Forward Voltage Vf(V)			Dynamic Resistance(Ω)	Temperature Coefficient of Vf(mV/°C) ΔVf/ΔTj	Thermal Resistance Junction to Board(°C/W)
	Min.	Typ.	Max.			
White	2.79	3.55	3.99	1.0	-2	15
Warm White	2.79	3.55	3.99	1.0	-2	15
Green	2.79	3.55	3.99	1.0	-2	15
Blue	2.79	3.55	3.99	1.0	-2	15
Amber	1.90	2.20	3.10	2.4	-2	15
Red-Orange	1.90	2.20	3.10	2.4	-2	15
Red	1.90	2.20	3.10	2.4	-2	15

Absolute Maximum Ratings

Parameter	White/Warm White/Green/Blue	Amber/Red-Orange/Red
DC Forward Current (mA)	350	385
Peak Pulsed Forward Current (mA)	500	550
Average Forward Current (mA)	350	350
ESD Sensitivity	±16000V HBM	
LED Junction Temperature (°C)	135	120
Aluminum-core PCB Temperature(°C)	105	105
Storage & Operating Temperature(°C)	-40 to +105	-40 to +105
Soldering Temperature(°C)	260 for 5 seconds Max.	

Photometric Luminous Flux Bin Structure

Bin Code	Minimum Photometric Flux (lm)	Maximum Photometric Flux (lm)
F	2.9	3.8
G	3.8	4.9
H	4.9	6.3
J	6.3	8.2
K	8.2	10.7
L	10.7	13.9
M	13.9	18.1
N	18.1	23.5
P	23.5	30.6
Q	30.6	39.8
R	39.8	51.7

- Tolerance on each Luminous Flux bin is ± 15%

Color Bins for Amber

Bin Code	Minimum Dominant Wavelength (nm)	Maximum Dominant Wavelength (nm)
1	584.5	587.0
2	587.0	589.5
4	589.5	592.0
6	592.0	594.5
7	594.5	597.0

- Tolerance on each Color bin is ± 1nm

Color Bins for Red-Orange

Bin Code	Minimum Dominant Wavelength (nm)	Maximum Dominant Wavelength (nm)
1	610.0	613.5
2	613.5	620.5

- Tolerance on each Color bin is ± 1nm

Color Bins for Red

Bin Code	Minimum Dominant Wavelength (nm)	Maximum Dominant Wavelength (nm)
2	613.5	620.5
4	620.5	631.0
5	631.0	645.0

- Tolerance on each Color bin is ± 1 nm

Color Bins for Blue

Bin Code	Minimum Dominant Wavelength (nm)	Maximum Dominant Wavelength (nm)
1	460	465
2	465	470
3	470	475
4	475	480
5	480	485
6	485	490

- Tolerance on each Color bin is ± 1 nm

Color Bins for Green

Bin Code	Minimum Dominant Wavelength (nm)	Maximum Dominant Wavelength (nm)
1	520	525
2	525	530
3	530	535
4	535	540
5	540	545
6	545	550

- Tolerance on each Color bin is ± 1 nm

Color Bins for White

Bin Code	X	Y	Typ. CCT (K)	Bin Code	X	Y	Typ. CCT (K)
	0.346	0.359			0.316	0.333	
V0	0.344	0.344	5350	X0	0.317	0.32	6700
	0.329	0.331			0.308	0.311	
	0.329	0.345			0.305	0.322	
	0.367	0.4			0.329	0.369	
V1	0.362	0.372	5500	X1	0.329	0.345	6300
	0.329	0.345			0.305	0.322	
	0.329	0.369			0.301	0.342	
	0.329	0.345			0.308	0.311	
W0	0.329	0.331	6050	YA	0.311	0.293	8000
	0.317	0.32			0.29	0.27	
	0.316	0.333			0.283	0.284	
	0.329	0.331			0.303	0.333	
WA	0.33	0.31	6300	Y0	0.308	0.311	8000
	0.311	0.293			0.283	0.284	
	0.308	0.311			0.274	0.301	

- Tolerance on each Color bin (x , y) is ± 0.01

Color Bins for White

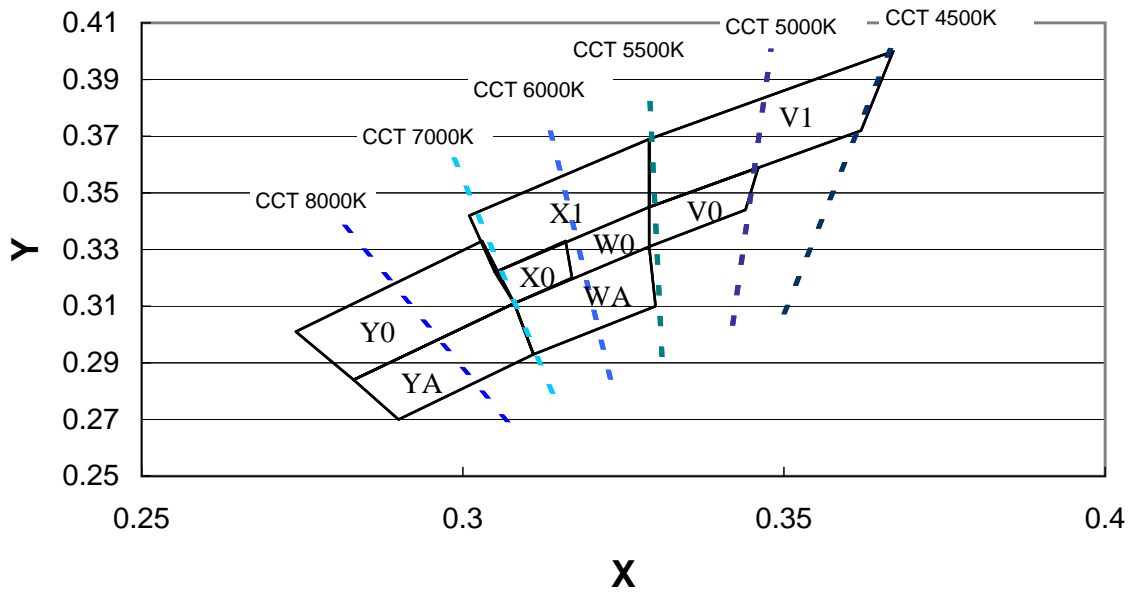

Color Bins for Warm White

Bin Code	X	Y	Typ. CCT (K)	Bin Code	X	Y	Typ. CCT (K)
	0.438	0.412			0.409	0.4	
	0.429	0.394			0.402	0.382	
N0	0.444	0.399	2950	Q0	0.416	0.389	3370
	0.453	0.416			0.424	0.406	
	0.438	0.412			0.409	0.4	
	0.454	0.446			0.392	0.391	
	0.438	0.412			0.387	0.374	
N1	0.453	0.416	2950	R0	0.402	0.382	3640
	0.471	0.451			0.409	0.4	
	0.454	0.446			0.392	0.391	
	0.424	0.406			0.402	0.423	
	0.416	0.389			0.392	0.391	
P0	0.429	0.394	3150	R1	0.424	0.406	3500
	0.438	0.412			0.438	0.44	
	0.424	0.406			0.402	0.423	
	0.438	0.44			0.387	0.374	
	0.424	0.406			0.383	0.36	
P1	0.438	0.412	3150	RA	0.41	0.374	3500
	0.454	0.446			0.416	0.389	
	0.438	0.44			0.387	0.374	

- Tolerance on each Color bin (x , y) is ± 0.01

Color Bins for Warm White

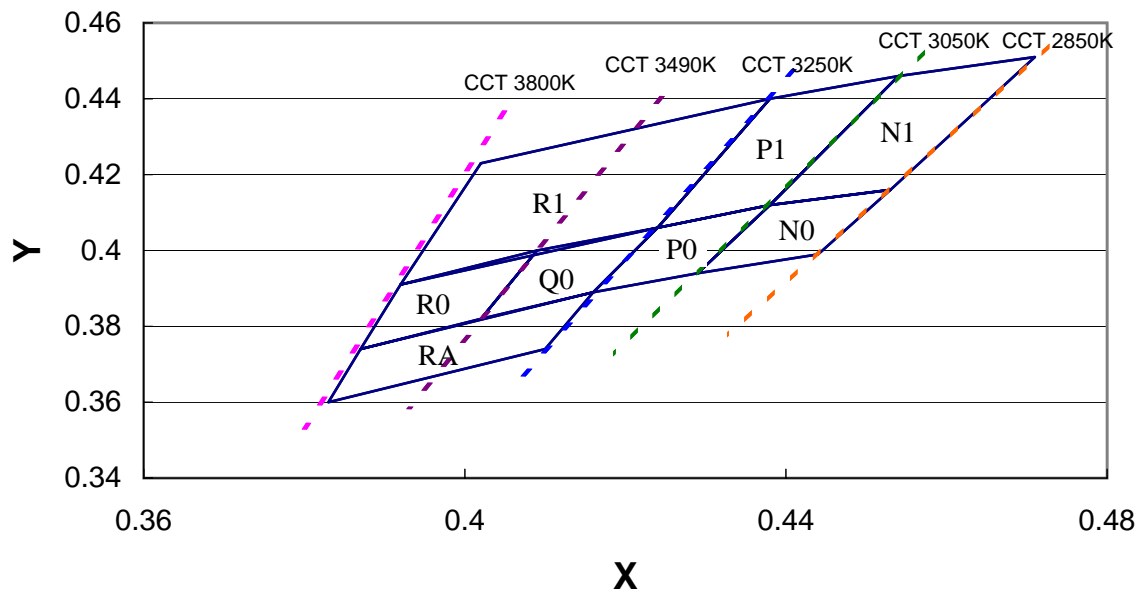

Wavelength Characteristics, $T_j=25^\circ\text{C}$

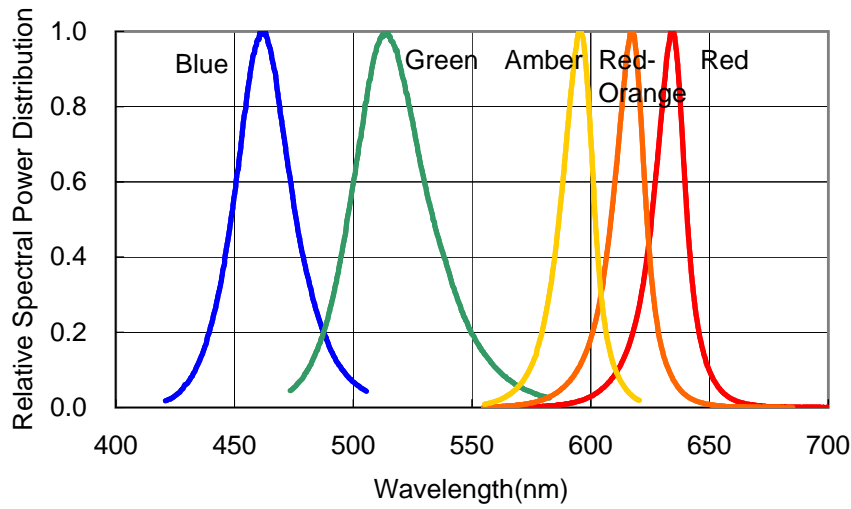

Figure 1a. Relative Intensity vs. Wavelength

White Color Spectrum

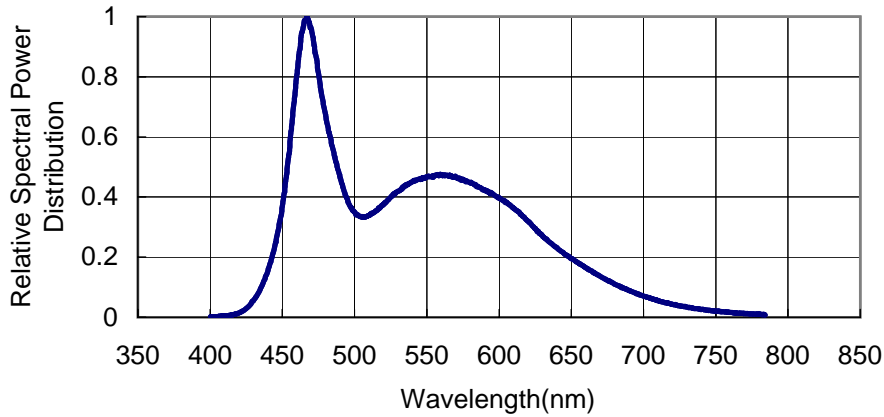

Figure 1b. White Color Spectrum of Typical 5500K Part.

Warm White Color Spectrum

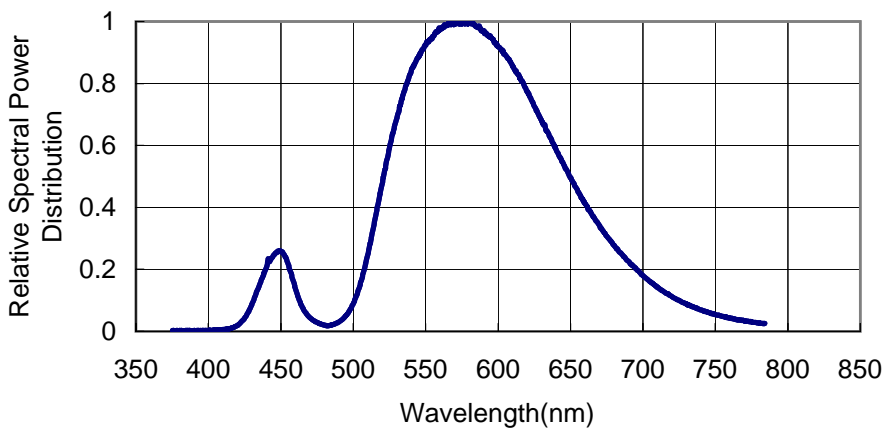

Figure 1c. Warm White Color Spectrum of Typical 3300K Part.

Light Output Characteristics

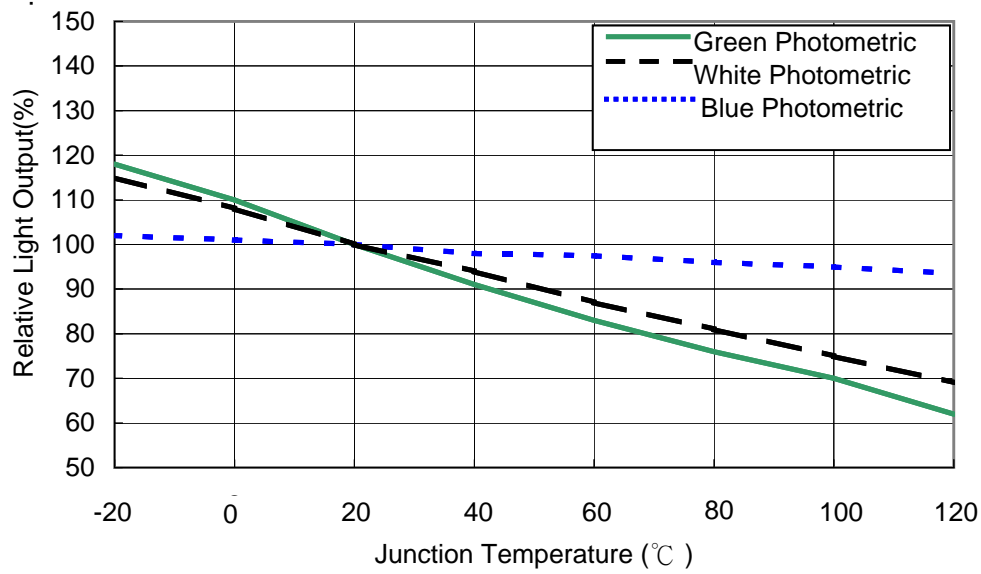

Figure 2a. Relative Light Output vs. Junction Temperature

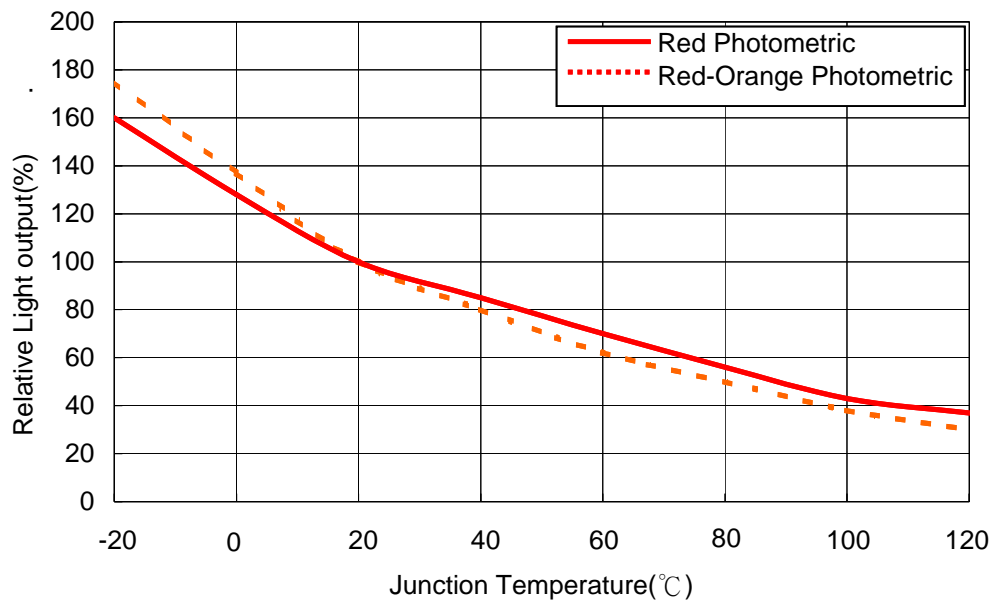

Figure 2b. Relative Light Output vs. Junction Temperature

Forward Current Characteristics, $T_j=25^\circ\text{C}$

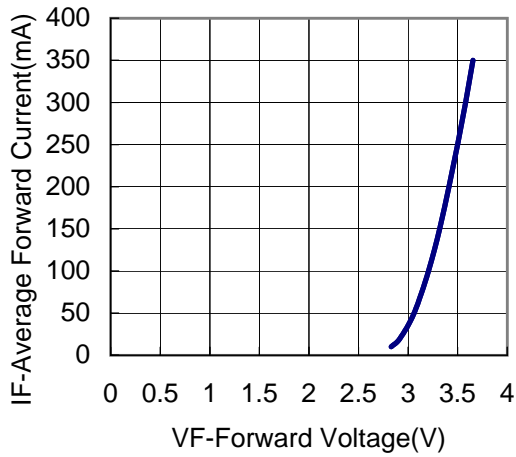

Fig 3a. Forward Current vs. Forward Voltage for White, Warm White, Blue and Green.

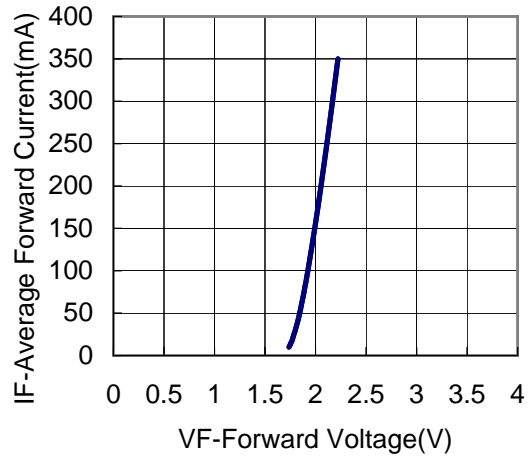

Fig 3b. Forward Current vs. Forward Voltage for Amber, Red-Orange and Red.

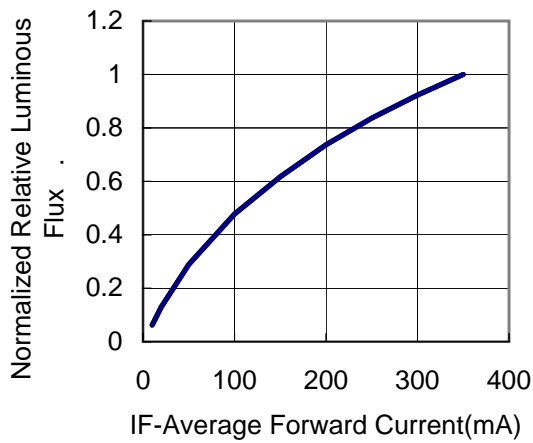

Fig 4a. Relative Luminous Flux vs. Forward Current for White, Warm White, Blue and Green at $T_j=25^\circ\text{C}$ maintained.

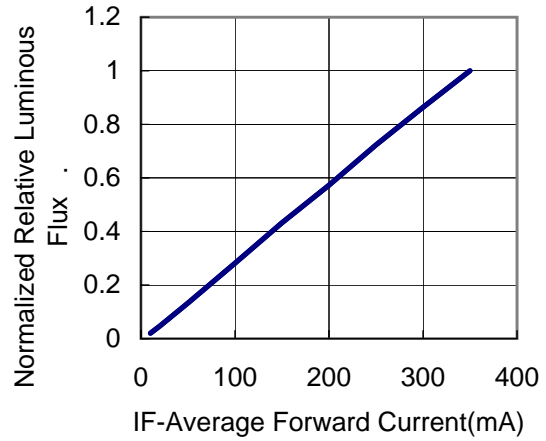

Fig 4b. Relative Luminous Flux vs. Forward Current for Amber, Red-Orange, Red at $T_j=25^\circ\text{C}$ maintained.

Current Derating Curves

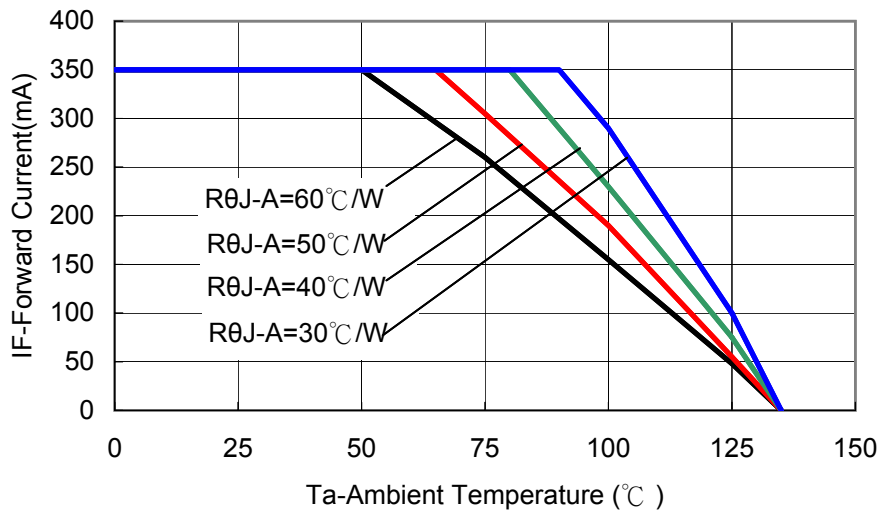

Fig 5a. Maximum Forward Current vs. Ambient Temperature. Derating based on $T_{jMAX}=135^{\circ}C$ for White, Warm White, Blue and Green.

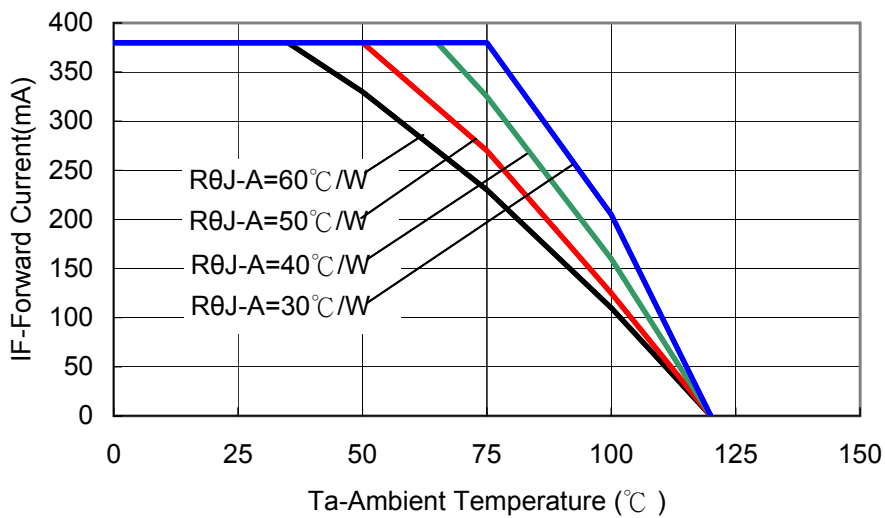

Fig 5b. Maximum Forward Current vs. Ambient Temperature. Derating based on $T_{jMAX}=120^{\circ}C$ for Amber, Red-Orange and Red.

Typical Representative Spatial Radiation Pattern

Lambertian Radiation Pattern

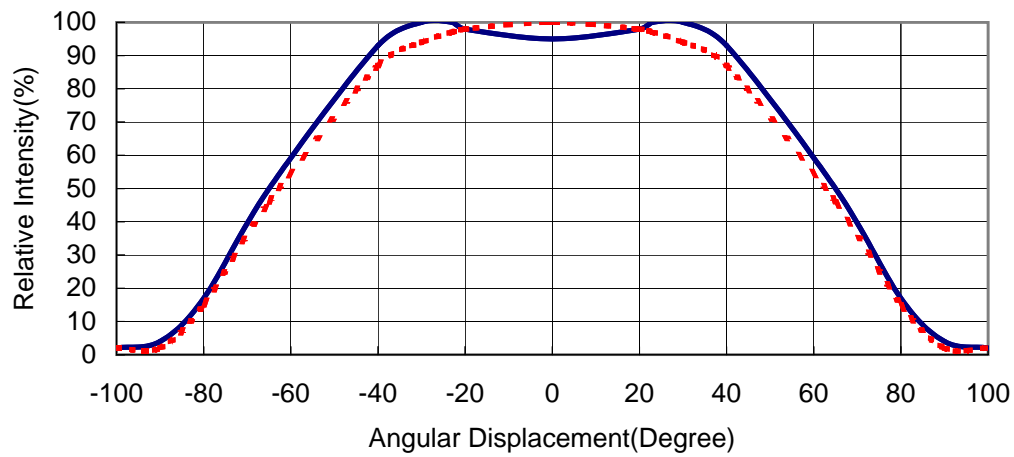

Fig 6. Typical Representative Spatial Radiation Pattern for White, Warm White, Blue, Green, Amber, Red-Orange and Red.